

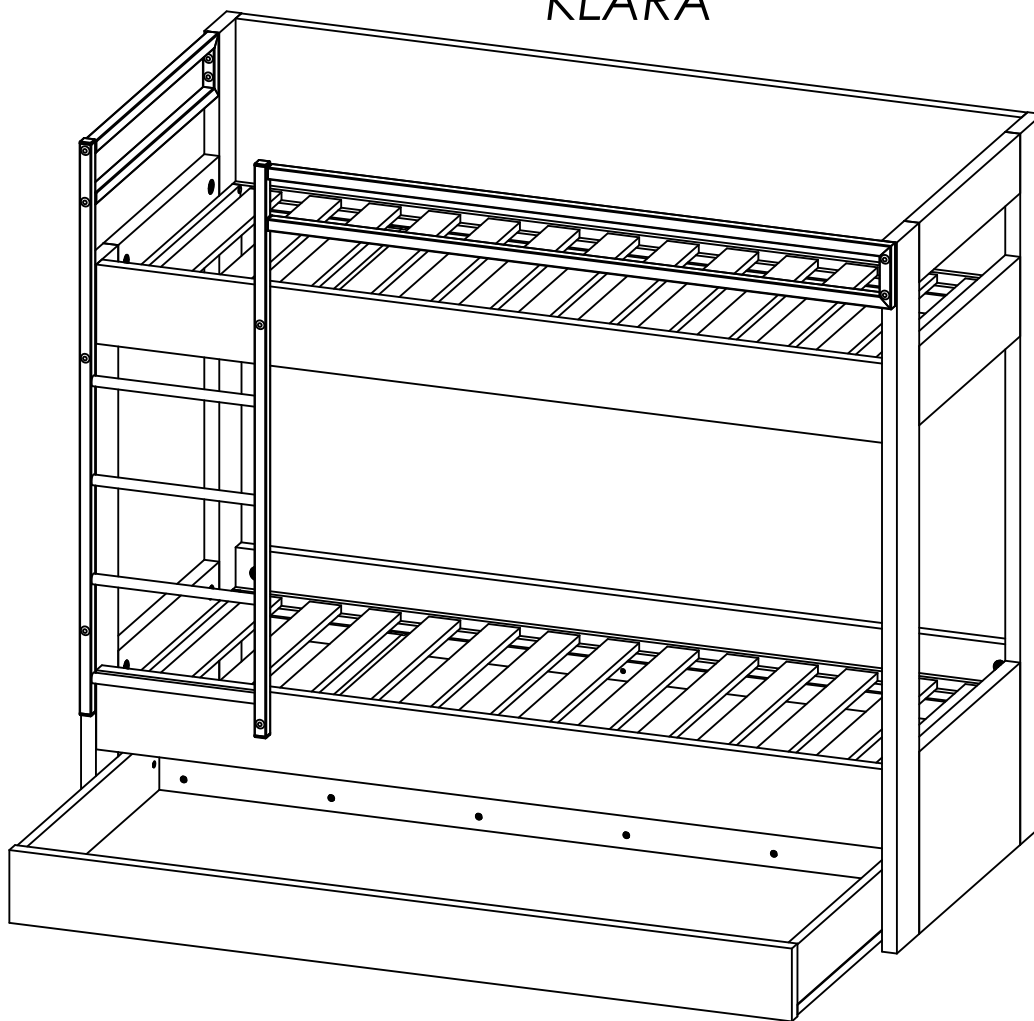

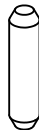







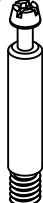



# Poschodová posteľ KLÁRA

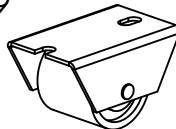

1  kolík 144 ks	2  závrtná matica 34 ks	3  ťahlo 34 ks	4  excenter 35mm 34 ks	5  konfirmát 7x60 20 ks	6  ťahlo 16 ks
7  excenter záhlbný 15mm 16 ks	8  skrutka 3x16 12 ks	9  pojazdové koliesko 6 ks			
10  skrutka 4x30 2 ks	11  skrutka 5x70 6 ks	12  skrutka imbus 8x35 4 ks	13  záslepka 4 ks	14  krytka 12 ks	

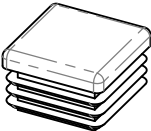

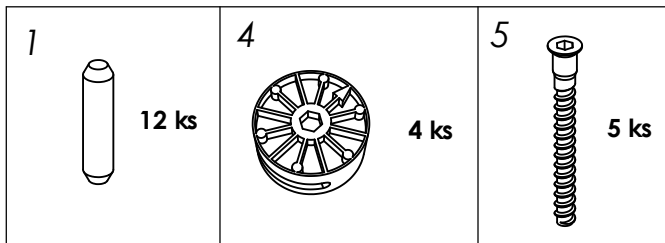

Imbusový kľúč 4mm, 6mm a 8mm

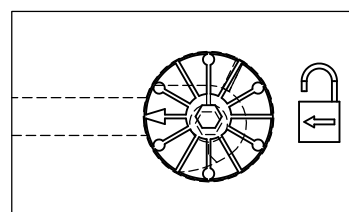
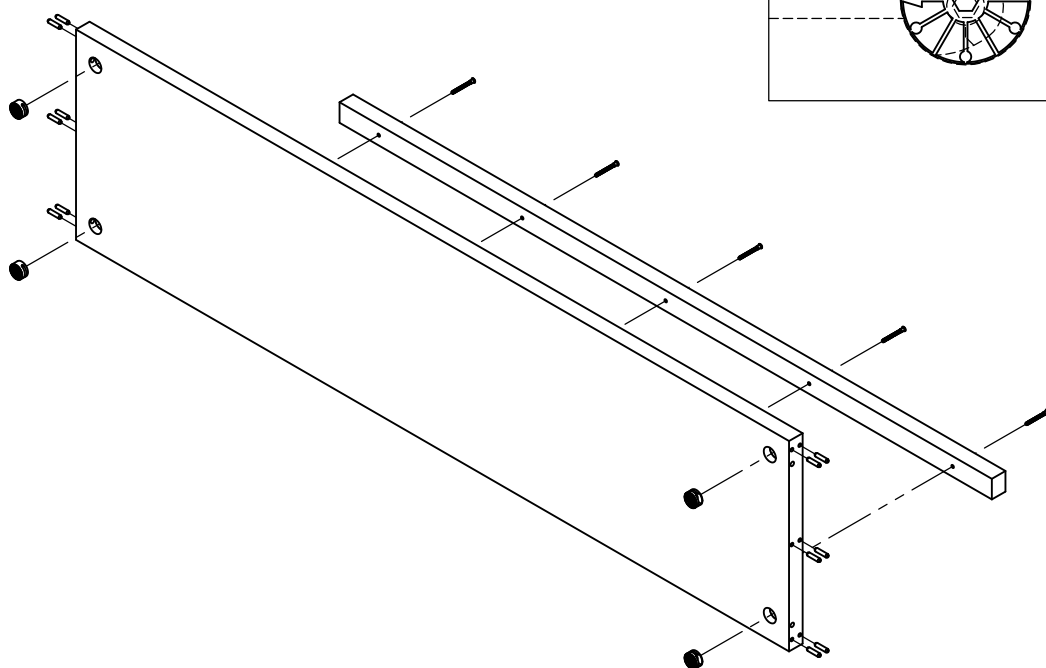
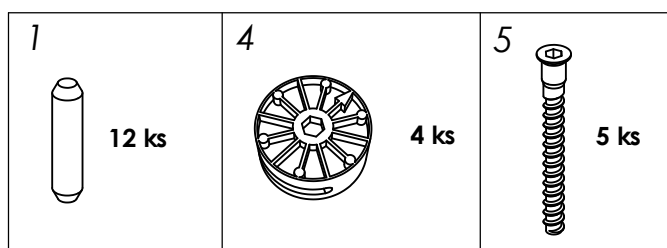
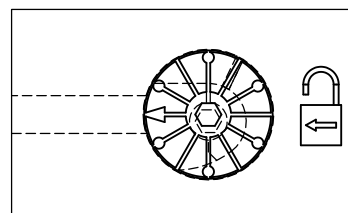
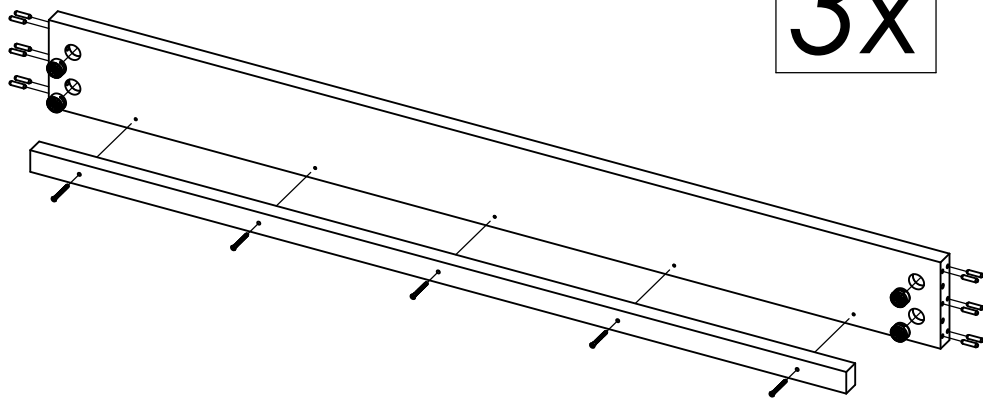

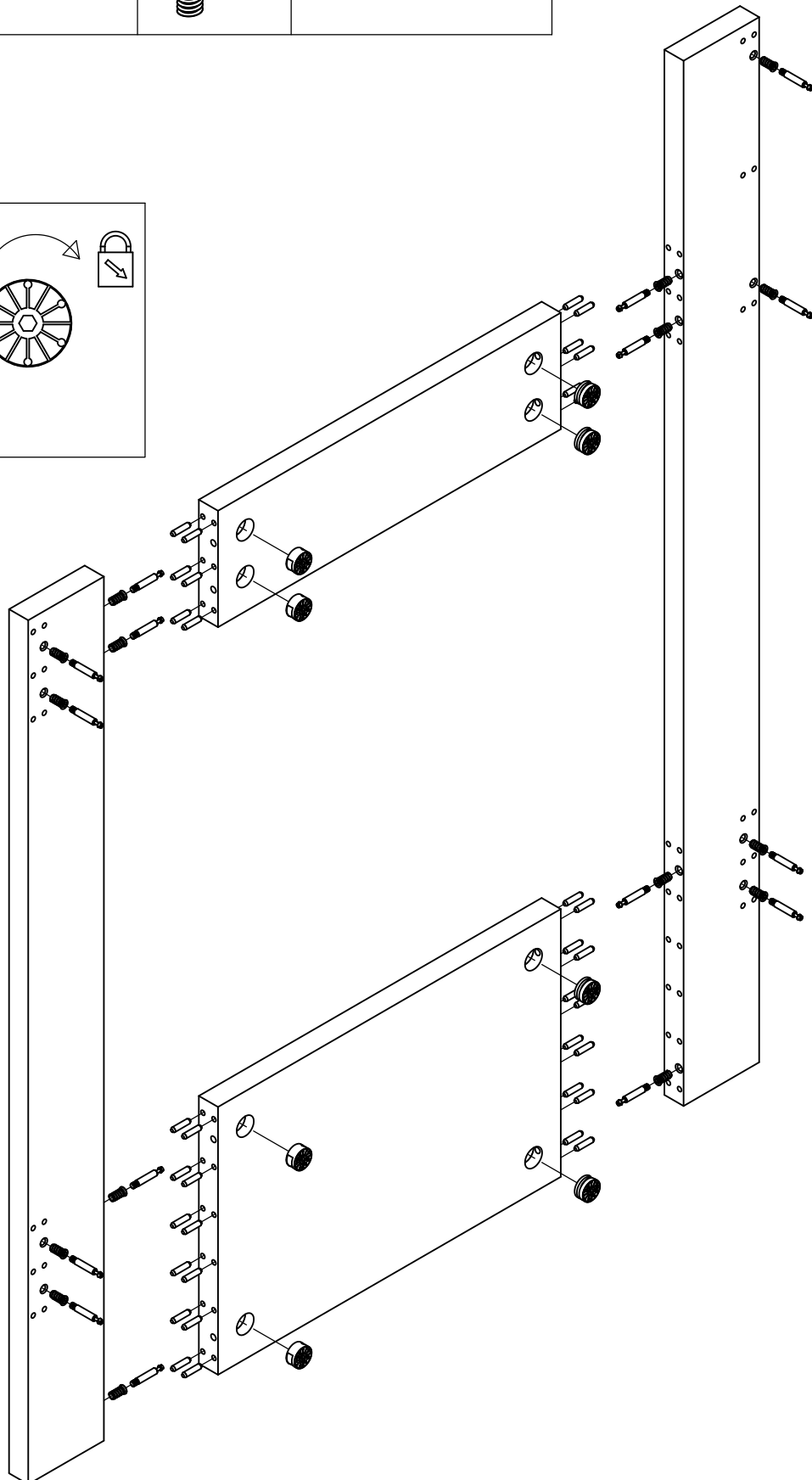
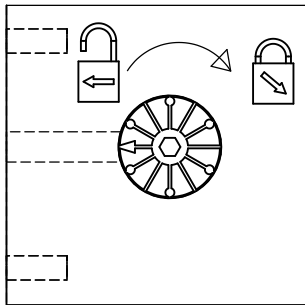
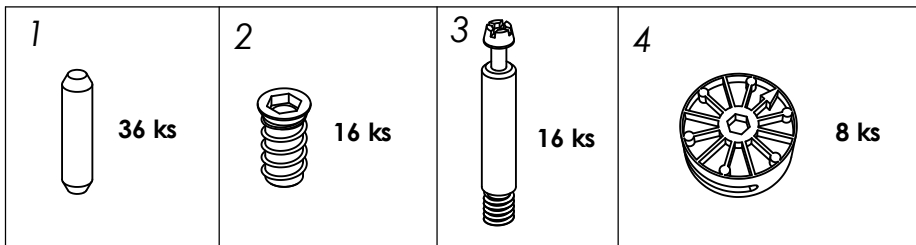
3x





<p>1</p>  <p>40 ks</p>	<p>2</p>  <p>18 ks</p>	<p>3</p>  <p>18 ks</p>	<p>4</p>  <p>10 ks</p>
---	---	---	---

